

## Optocoupler, Phototransistor Output, 4 Pin LSOP, Long Creepage Mini-Flat Package

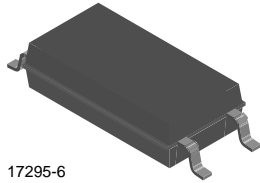

17295-6

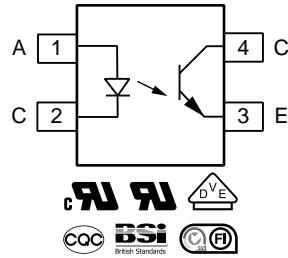

### FEATURES

- Low profile package
- High collector emitter voltage,  $V_{CEO} = 80\text{ V}$
- Isolation test voltage,  $5000\text{ V}_{RMS}$
- Isolation voltage  $V_{IORM} = 1050\text{ V}_{peak}$
- Low coupling capacitance
- High common mode transient immunity
- Material categorization: for definitions of compliance please see [www.vishay.com/doc?99912](http://www.vishay.com/doc?99912)



### DESCRIPTION

The VOL617A has a GaAs infrared emitting diode emitter, which is optically coupled to a silicon planar phototransistor detector, and is incorporated in a 4 pin LSOP wide body package.

It features a high current transfer ratio, low coupling capacitance, and high isolation voltage.

The coupling device is designed for signal transmission between two electrically separated circuits.

### APPLICATIONS

- Telecom
- Industrial controls
- Battery powered equipment
- Office machines
- Programmable controllers

### AGENCY APPROVALS

(All parts are certified under base model VOL617A)

- UL1577, file no. E76222
- cUL CSA 22.2 bulletin 5A, double protection
- DIN EN 60747-5-5 (VDE 0884-5), available with option 1
- BSI: EN 60065:2002, EN 60950-1:2006
- FIMKO EN60950-1
- CQC: GB8898-2011, GB4943.1-2011

ORDERING INFORMATION								
<div style="display: flex; justify-content: space-around; align-items: center;"> <div style="border: 1px solid black; padding: 2px;">V</div> <div style="border: 1px solid black; padding: 2px;">O</div> <div style="border: 1px solid black; padding: 2px;">L</div> <div style="border: 1px solid black; padding: 2px;">6</div> <div style="border: 1px solid black; padding: 2px;">1</div> <div style="border: 1px solid black; padding: 2px;">7</div> <div style="border: 1px solid black; padding: 2px;">A</div> <div style="border: 1px solid black; padding: 2px;">-</div> <div style="border: 1px solid black; padding: 2px;">#</div> <div style="border: 1px solid black; padding: 2px;">X</div> <div style="border: 1px solid black; padding: 2px;">0</div> <div style="border: 1px solid black; padding: 2px;">0</div> <div style="border: 1px solid black; padding: 2px;">1</div> <div style="border: 1px solid black; padding: 2px;">T</div> </div>		PART NUMBER		CTR BIN	PACKAGE OPTION		TAPE AND REEL	
AGENCY CERTIFIED/ PACKAGE	CTR (%)							
	5 mA							
UL, cUL, BSI, FIMKO, CQC	50 to 600	40 to 80	63 to 125	100 to 200	160 to 320	80 to 160	130 to 260	
4 pin LSOP, mini-flat, long creepage	VOL617AT	VOL617A-1T	VOL617A-2T	VOL617A-3T	VOL617A-4T	-	-	
UL, cUL, BSI, FIMKO, CQC, VDE (option 1)	50 to 600	40 to 80	63 to 125	100 to 200	160 to 320	80 to 160	130 to 260	
4 pin LSOP, mini-flat, long creepage	VOL617A-X001T	VOL617A-1X001T	VOL617A-2X001T	VOL617A-3X001T	VOL617A-4X001T	VOL617A-7X001T	VOL617A-8X001T, VOL617A-8X001T3 <sup>(1)</sup>	

#### Note

<sup>(1)</sup> Product is rotated 180° in tape and reel cavity



<b>ABSOLUTE MAXIMUM RATINGS</b> ( $T_{amb} = 25\text{ }^{\circ}\text{C}$ , unless otherwise specified)				
PARAMETER	TEST CONDITION	SYMBOL	VALUE	UNIT
<b>INPUT</b>				
Reverse voltage		$V_R$	6	V
Power dissipation		$P_{diss}$	100	mW
Forward surge current	$t_p < 10\text{ }\mu\text{s}$	$I_{FSM}$	1.5	A
Forward current		$I_F$	60	mA
Junction temperature		$T_j$	125	$^{\circ}\text{C}$
<b>OUTPUT</b>				
Collector emitter voltage		$V_{CEO}$	80	V
Emitter collector voltage		$V_{ECO}$	7	V
Collector current		$I_C$	50	mA
	$t_p/T = 0.5, t_p < 10\text{ ms}$	$I_C$	100	mA
Power dissipation		$P_{diss}$	150	mW
Junction temperature		$T_j$	125	$^{\circ}\text{C}$
<b>COUPLER</b>				
Total power dissipation		$P_{tot}$	250	mW
Storage temperature range		$T_{stg}$	-55 to +125	$^{\circ}\text{C}$
Ambient temperature range		$T_{amb}$	-55 to +110	$^{\circ}\text{C}$
Soldering temperature <sup>(1)</sup>	$\leq 10\text{ s}$	$T_{sld}$	260	$^{\circ}\text{C}$

**Notes**

- Stresses in excess of the absolute maximum ratings can cause permanent damage to the device. Functional operation of the device is not implied at these or any other conditions in excess of those given in the operational sections of this document. Exposure to absolute maximum ratings for extended periods of the time can adversely affect reliability
- <sup>(1)</sup> Refer to reflow profile for soldering conditions for surface mounted devices

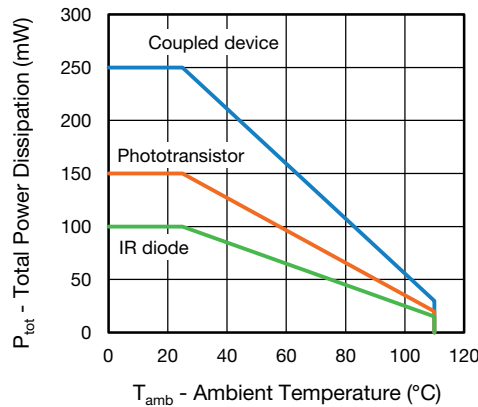

Fig. 1 - Total Power Dissipation vs. Ambient Temperature

<b>ELECTRICAL CHARACTERISTICS</b> ( $T_{amb} = 25\text{ }^{\circ}\text{C}$ , unless otherwise specified)						
PARAMETER	TEST CONDITION	SYMBOL	MIN.	TYP.	MAX.	UNIT
<b>INPUT</b>						
Forward voltage	$I_F = 5\text{ mA}$	$V_F$	-	1.16	1.5	V
Capacitance	$V_R = 0\text{ V}$ , $f = 1\text{ MHz}$	$C_O$	-	45		pF
Reverse current	$V_R = 6\text{ V}$	$I_R$	-		100	$\mu\text{A}$
<b>OUTPUT</b>						
Collector emitter leakage current	$V_{CE} = 10\text{ V}$ , $I_F = 0\text{ A}$	$I_{CEO}$	-	10	200	nA
Collector emitter capacitance	$V_{CE} = 5\text{ V}$ , $f = 1\text{ MHz}$	$C_{CE}$	-	7	-	pF
<b>COUPLER</b>						
Collector emitter saturation voltage	$I_C = 1.0\text{ mA}$ , $I_F = 5\text{ mA}$	$V_{CEsat}$	-	0.25	0.4	V
Coupling capacitance	$f = 1\text{ MHz}$	$C_C$	-	0.25	-	pF

**Note**

- Minimum and maximum values are testing requirements. Typical values are characteristics of the device and are the result of engineering evaluation. Typical values are for information only and are not part of the testing requirements

<b>CURRENT TRANSFER RATIO</b> ( $T_{amb} = 25\text{ }^{\circ}\text{C}$ , unless otherwise specified)							
PARAMETER	TEST CONDITION	PART	SYMBOL	MIN.	TYP.	MAX.	UNIT
$I_C/I_F$	$I_F = 5\text{ mA}$ , $V_{CE} = 5\text{ V}$	VOL617A	CTR	50	-	600	%
		VOL617A-1	CTR	40	-	80	%
		VOL617A-2	CTR	63	-	125	%
		VOL617A-3	CTR	100	-	200	%
		VOL617A-4	CTR	160	-	320	%
		VOL617A-7	CTR	80	-	160	%
		VOL617A-8	CTR	130	-	260	%

<b>SWITCHING CHARACTERISTICS</b> ( $T_{amb} = 25\text{ }^{\circ}\text{C}$ , unless otherwise specified)							
PARAMETER	TEST CONDITION	SYMBOL	MIN.	TYP.	MAX.	UNIT	
Turn on time	$V_{CC} = 5\text{ V}$ , $I_C = 2\text{ mA}$ , $R_L = 100\ \Omega$	$t_{on}$	-	6	-	$\mu\text{s}$	
Rise time	$V_{CC} = 5\text{ V}$ , $I_C = 2\text{ mA}$ , $R_L = 100\ \Omega$	$t_r$	-	3.5	-	$\mu\text{s}$	
Turn off time	$V_{CC} = 5\text{ V}$ , $I_C = 2\text{ mA}$ , $R_L = 100\ \Omega$	$t_{off}$	-	5.5	-	$\mu\text{s}$	
Fall time	$V_{CC} = 5\text{ V}$ , $I_C = 2\text{ mA}$ , $R_L = 100\ \Omega$	$t_f$	-	5	-	$\mu\text{s}$	

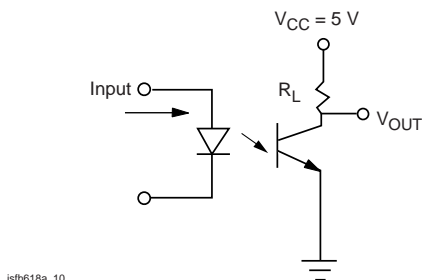

Fig. 2 - Test Circuit

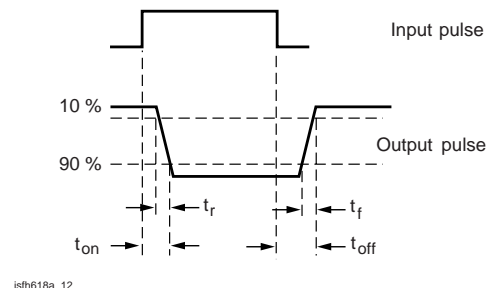

Fig. 3 - Test Circuit and Waveforms

SAFETY AND INSULATION RATINGS				
PARAMETER	TEST CONDITION	SYMBOL	VALUE	UNIT
Climatic classification	According to IEC 68 part 1		55 / 110 / 21	
Pollution degree	According to DIN VDE 0109		2	
Comparative tracking index	Insulation group IIIa	CTI	275	
Maximum rated withstanding isolation voltage	According to UL1577, t = 1 min	$V_{ISO}$	5000	$V_{RMS}$
Maximum transient isolation voltage	According to DIN EN 60747-5-5	$V_{IOTM}$	8000	$V_{peak}$
Maximum repetitive peak isolation voltage	According to DIN EN 60747-5-5	$V_{IORM}$	1050	$V_{peak}$
Isolation resistance	$T_{amb} = 25\text{ }^{\circ}\text{C}$ , $V_{IO} = 500\text{ V}$	$R_{IO}$	$\geq 10^{12}$	$\Omega$
	$T_{amb} = 100\text{ }^{\circ}\text{C}$ , $V_{IO} = 500\text{ V}$	$R_{IO}$	$\geq 10^{11}$	$\Omega$
	$T_{amb} = TS$ , $V_{IO} = 500\text{ V}$	$R_{IO}$	$\geq 10^9$	$\Omega$
Output safety power		$P_{SO}$	265	mW
Input safety current		$I_{SI}$	130	mA
Input safety temperature		$T_S$	150	$^{\circ}\text{C}$
Creepage distance			$\geq 8$	mm
Clearance distance			$\geq 8$	mm
Insulation thickness		DTI	$\geq 0.4$	mm
Input to output test voltage, method B	$V_{IORM} \times 1.875 = V_{PR}$ , 100 % production test with $t_M = 1\text{ s}$ , partial discharge $< 5\text{ pC}$	$V_{PR}$	2000	$V_{peak}$
Input to output test voltage, method A	$V_{IORM} \times 1.6 = V_{PR}$ , 100 % sample test with $t_M = 10\text{ s}$ , partial discharge $< 5\text{ pC}$	$V_{PR}$	1680	$V_{peak}$

**Note**

- According to DIN EN 60747-5-5 (VDE 0884), § 7.4.3.8.2, (see Fig. 4). This optocoupler is suitable for safe electrical isolation only within the safety ratings. Compliance with the safety ratings shall be ensured by means of suitable protective circuits

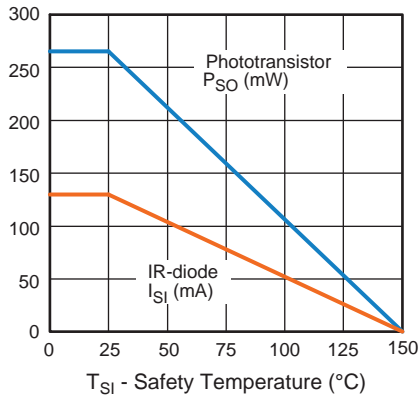

Fig. 4 - Derating Diagram

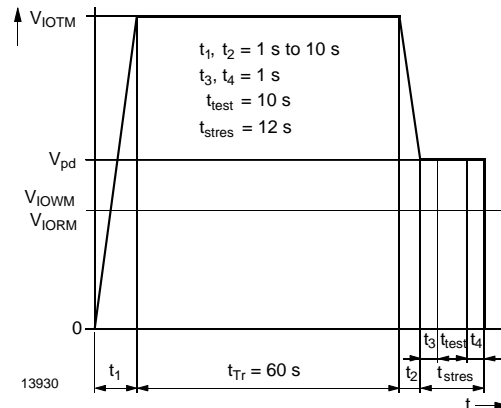

Fig. 5 - Test Pulse Diagram for Sample Test according to DIN EN 60747-5-5

**TYPICAL CHARACTERISTICS** ( $T_{amb} = 25\text{ }^{\circ}\text{C}$ , unless otherwise specified)

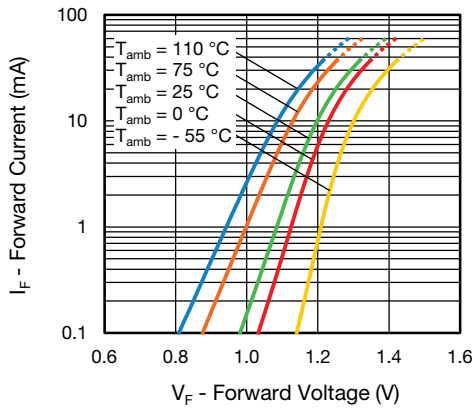

Fig. 6 - Forward Current vs. Forward Voltage

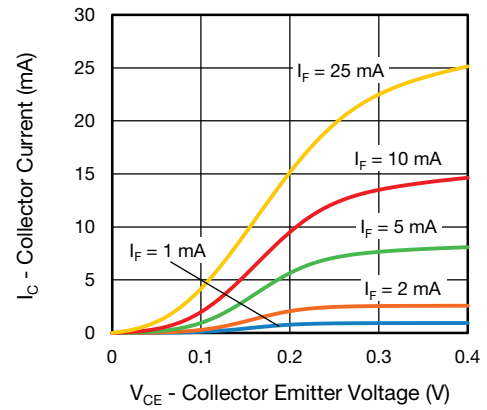

Fig. 9 - Collector Current vs. Collector Emitter Voltage

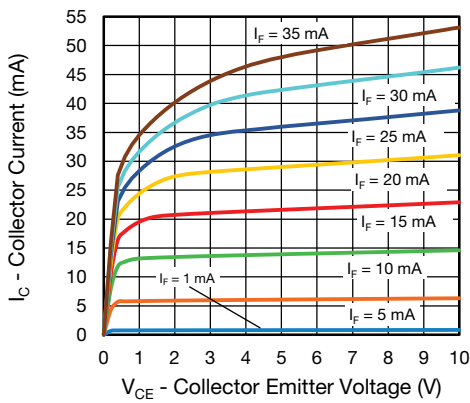

Fig. 7 - Collector Current vs. Collector Emitter Voltage

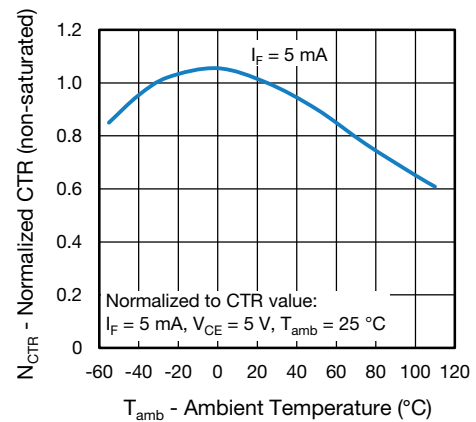

Fig. 10 - Normalized Current Transfer Ratio (non-saturated) vs. Ambient Temperature

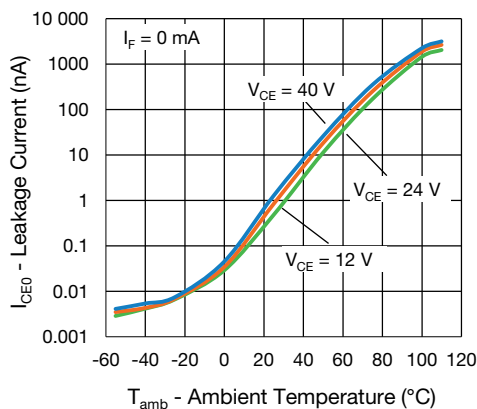

Fig. 8 - Collector Emitter Current vs. Ambient Temperature

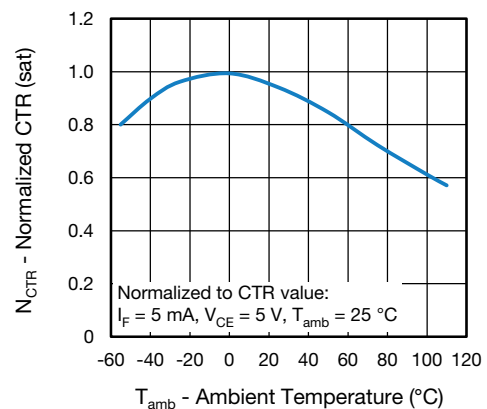

Fig. 11 - Normalized Current Transfer Ratio (saturated) vs. Ambient Temperature



Fig. 12 - Normalized Current Transfer Ratio (non-saturated) vs. Forward Current

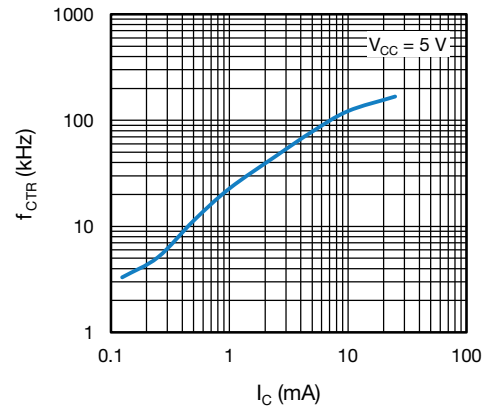

Fig. 15 - Cut-Off Frequency vs. Collector Current

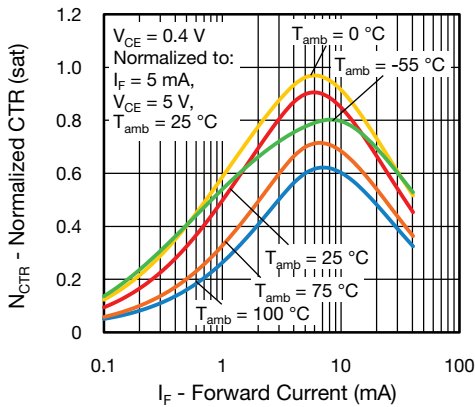

Fig. 13 - Normalized Current Transfer Ratio (saturated) vs. Forward Current

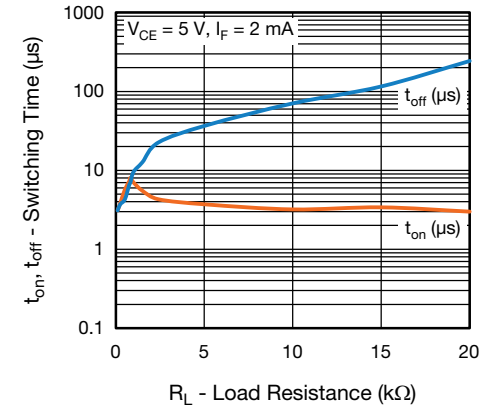

Fig. 16 - Switching Time vs. Load Resistance

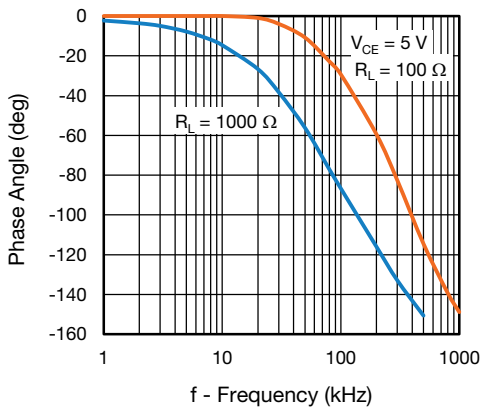

Fig. 14 - Cut-Off Frequency vs. Phase Angle

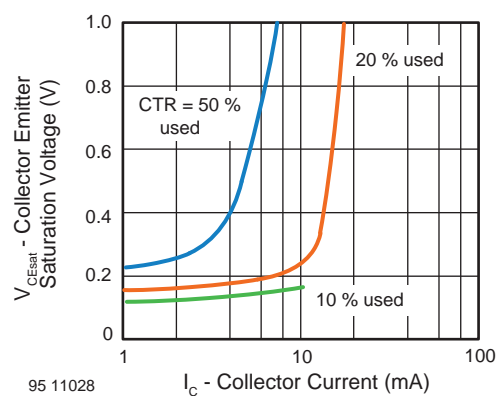

Fig. 17 - Collector Emitter Saturation Voltage vs. Collector Current

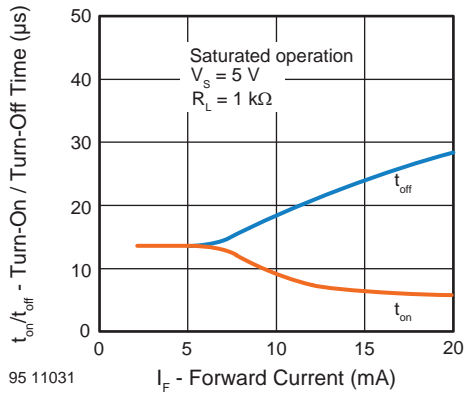
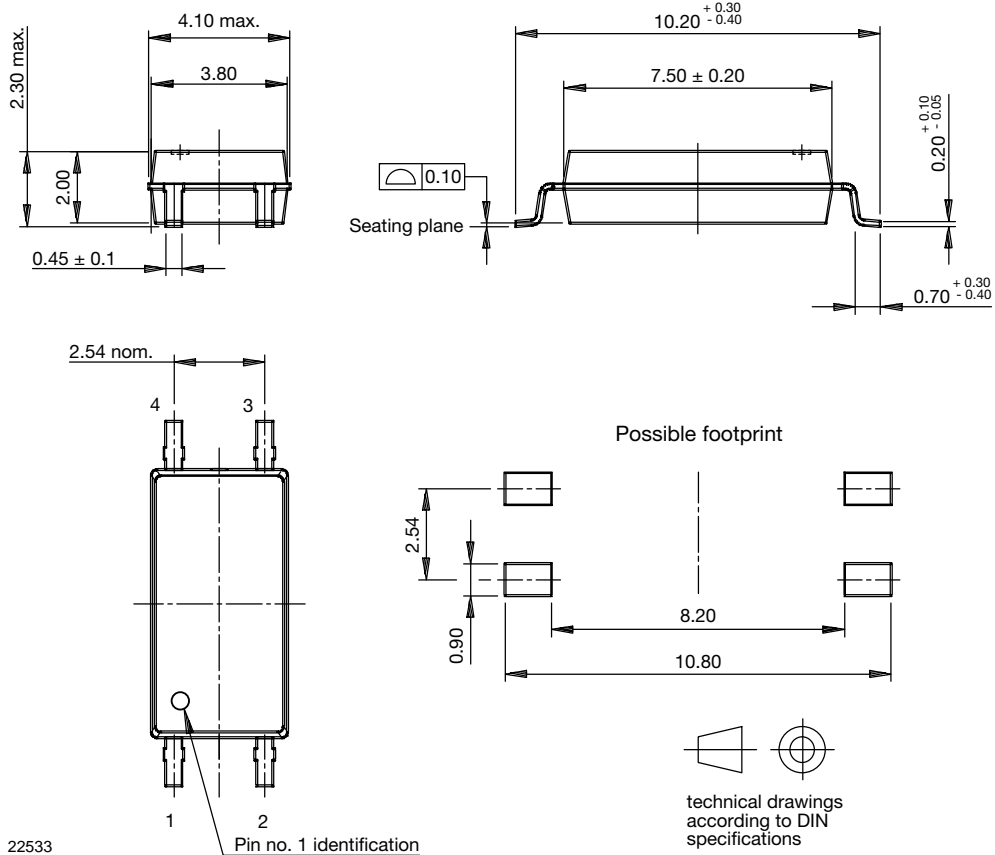
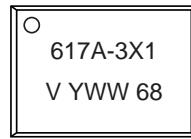

Fig. 18 - Turn-On / Turn-Off Time vs. Forward Current

**PACKAGE DIMENSIONS** (in millimeters)



**PACKAGE MARKING** (example of VOL617A-3X001T)



**Notes**

- Only option 1 is reflected in the package marking with the characters “X1”
- Tape and reel suffix (T) is not part of the package marking

**TAPE AND REEL DIMENSIONS** (in millimeters)

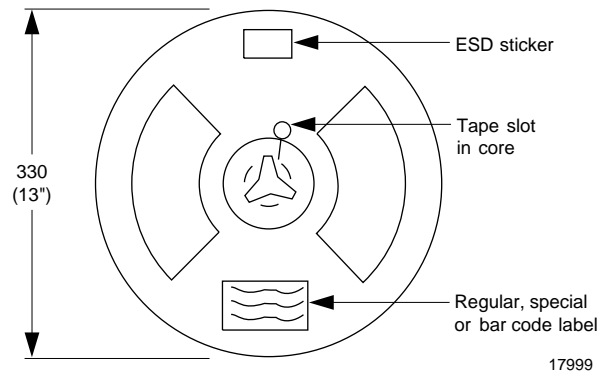

Fig. 19 - Reel Dimensions (3000 units per reel)

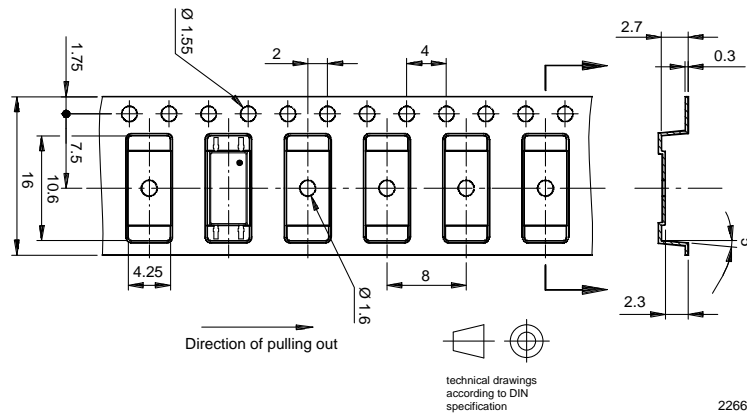

Fig. 20 - Tape and Reel Packing for VOL617A-xT

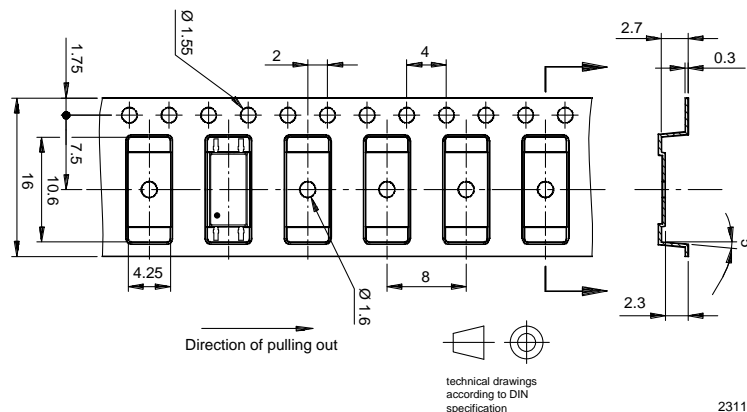
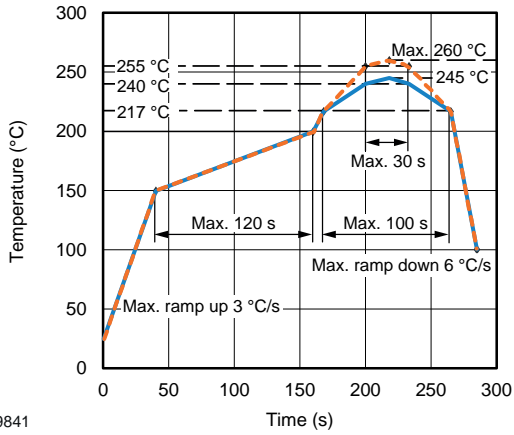

Fig. 21 - Tape and Reel Packing for VOL617A-xT3



**SOLDER PROFILE**



19841

Fig. 22 - Lead (Pb)-free Reflow Solder Profile According to J-STD-020

**HANDLING AND STORAGE CONDITIONS**

ESD level: HBM class 2

Floor life: unlimited

Conditions:  $T_{amb} < 30\text{ °C}$ , RH < 85 %

Moisture sensitivity level 1, according to J-STD-020



## **Disclaimer**

ALL PRODUCT, PRODUCT SPECIFICATIONS AND DATA ARE SUBJECT TO CHANGE WITHOUT NOTICE TO IMPROVE RELIABILITY, FUNCTION OR DESIGN OR OTHERWISE.

Vishay Intertechnology, Inc., its affiliates, agents, and employees, and all persons acting on its or their behalf (collectively, "Vishay"), disclaim any and all liability for any errors, inaccuracies or incompleteness contained in any datasheet or in any other disclosure relating to any product.

Vishay makes no warranty, representation or guarantee regarding the suitability of the products for any particular purpose or the continuing production of any product. To the maximum extent permitted by applicable law, Vishay disclaims (i) any and all liability arising out of the application or use of any product, (ii) any and all liability, including without limitation special, consequential or incidental damages, and (iii) any and all implied warranties, including warranties of fitness for particular purpose, non-infringement and merchantability.

Statements regarding the suitability of products for certain types of applications are based on Vishay's knowledge of typical requirements that are often placed on Vishay products in generic applications. Such statements are not binding statements about the suitability of products for a particular application. It is the customer's responsibility to validate that a particular product with the properties described in the product specification is suitable for use in a particular application. Parameters provided in datasheets and / or specifications may vary in different applications and performance may vary over time. All operating parameters, including typical parameters, must be validated for each customer application by the customer's technical experts. Product specifications do not expand or otherwise modify Vishay's terms and conditions of purchase, including but not limited to the warranty expressed therein.

Except as expressly indicated in writing, Vishay products are not designed for use in medical, life-saving, or life-sustaining applications or for any other application in which the failure of the Vishay product could result in personal injury or death. Customers using or selling Vishay products not expressly indicated for use in such applications do so at their own risk. Please contact authorized Vishay personnel to obtain written terms and conditions regarding products designed for such applications.

No license, express or implied, by estoppel or otherwise, to any intellectual property rights is granted by this document or by any conduct of Vishay. Product names and markings noted herein may be trademarks of their respective owners.

# Mouser Electronics

Authorized Distributor

Click to View Pricing, Inventory, Delivery & Lifecycle Information:

[Vishay:](#)

[VOL617A-2X001](#) [VOL617AT](#) [VOL618AT](#) [VOL617A-7X001T](#)