

TLP387

1. Applications

- Programmable Logic Controllers (PLCs)
- I/O Interface Boards
- Home Electric Appliances

2. General

TLP387 is a photocoupler that consist of a InGaAs infrared emitting diode optically coupled to a darlington transistor. Housed in a SO6L (4 pin) package, it has a high noise immunity and a high insulation. With the high brakdown voltage between the collector and emitter, TLP387 is suitable in applications such as 100VDC output modules of programmable controllers.

3. Features

- (1) Collector-emitter voltage: 300 V (min)
- (2) Current transfer ratio: 1000 % (min) (@ $I_F = 1$ mA, $V_{CE} = 1$ V)
- (3) Isolation voltage: 5000 Vrms (min)
- (4) Operating temperature range: -55 to 110 °C
- (5) Safety standards
 - UL-approved: UL1577, File No.E67349
 - cUL-approved: CSA Component Acceptance Service No.5A File No.E67349
 - VDE-approved: EN60747-5-5, EN60065 or EN60950-1 (**Note 1**)
: EN62368-1 (Pending) (**Note 1**)
 - CQC-approved: GB4943.1, GB8898 Thailand Factory (Pending)



Note 1: When a VDE approved type is needed, please designate the **Option (D4)**.

4. Packaging and Pin Assignment

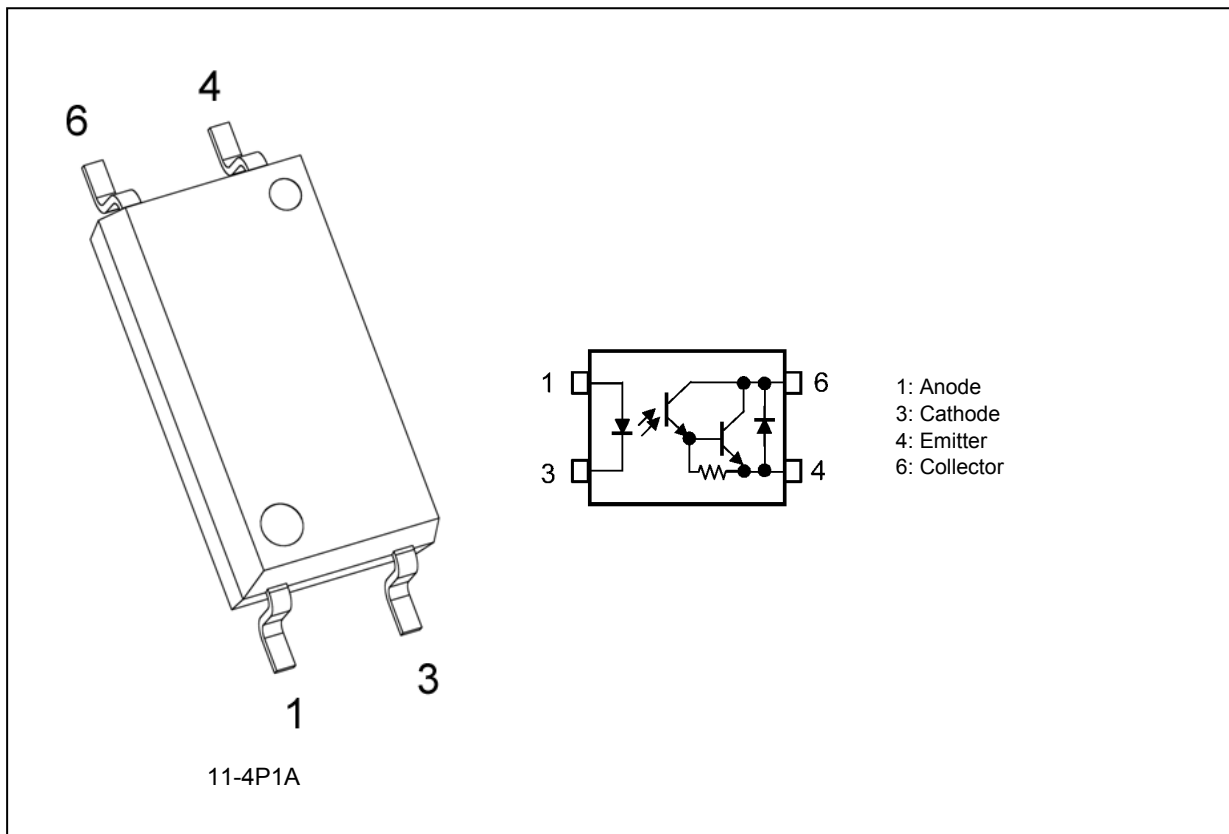

5. Mechanical Parameters

Characteristics	Min	Unit
Creepage distances	8.0	mm
Clearance	8.0	
Internal isolation thickness	0.4	

6. Absolute Maximum Ratings (Note) (Unless otherwise specified, T_a = 25 °C)

	Characteristics	Symbol	Note	Rating	Unit
LED	Input forward current	I _F		50	mA
	Input forward current derating (T _a ≥ 90 °C)	ΔI _F /ΔT _a		-1.43	mA/°C
	Input forward current (pulsed)	I _{FP}	(Note 1)	1	A
	Input power dissipation	P _D		100	mW
	Input power dissipation derating (T _a ≥ 90 °C)	ΔP _D /ΔT _a		-2.85	mW/°C
	Input reverse voltage	V _R		5	V
	Junction temperature	T _j		125	°C
Detector	Collector-emitter voltage	V _{CEO}		300	V
	Emitter-collector voltage	V _{ECO}		0.3	
	Collector current	I _C		150	mA
	Collector power dissipation	P _C		150	mW
	Collector power dissipation derating (T _a ≥ 25 °C)	ΔP _C /ΔT _a		-1.5	mW/°C
	Junction temperature	T _j		125	°C
Common	Operating temperature	T _{opr}		-55 to 110	°C
	Storage temperature	T _{stg}		-55 to 125	
	Lead soldering temperature (10 s)	T _{sol}		260	
	Total power dissipation	P _T		250	mW
	Total power dissipation derating (T _a ≥ 25 °C)	ΔP _T /ΔT _a		-2.5	mW/°C
	Isolation voltage AC, 60 s, R.H. ≤ 60 %	BV _S	(Note 2)	5000	V _{rms}

Note: Using continuously under heavy loads (e.g. the application of high temperature/current/voltage and the significant change in temperature, etc.) may cause this product to decrease in the reliability significantly even if the operating conditions (i.e. operating temperature/current/voltage, etc.) are within the absolute maximum ratings.

Please design the appropriate reliability upon reviewing the Toshiba Semiconductor Reliability Handbook ("Handling Precautions"/"Derating Concept and Methods") and individual reliability data (i.e. reliability test report and estimated failure rate, etc).

Note 1: Pulse width (PW) ≤ 0.1 ms, f = 1000 Hz

Note 2: This device is considered as a two-terminal device: Pins 1 and 3 are shorted together, and pin 4 and 6 are shorted together.

7. Electrical Characteristics (Unless otherwise specified, T_a = 25 °C)

	Characteristics	Symbol	Note	Test Condition	Min	Typ.	Max	Unit
LED	Input forward voltage	V _F		I _F = 10 mA	1.1	1.25	1.4	V
	Input reverse current	I _R		V _R = 5 V	—	—	10	μA
	Input capacitance	C _t		V = 0 V, f = 1 MHz	—	30	—	pF
Detector	Collector-emitter breakdown voltage	V _{(BR)CEO}		I _C = 0.1 mA	300	—	—	V
	Emitter-collector breakdown voltage	V _{(BR)ECO}		I _E = 0.1 mA	0.3	—	—	
	Dark Current	I _{DARK}		V _{CE} = 200 V	—	0.01	0.2	μA
				V _{CE} = 200 V, T _a = 85 °C	—	—	20	
Collector-emitter capacitance	C _{CE}			V = 0 V, f = 1 MHz	—	10	—	pF

8. Coupled Electrical Characteristics (Unless otherwise specified, $T_a = 25\text{ }^\circ\text{C}$)

Characteristics	Symbol	Note	Test Condition	Min	Typ.	Max	Unit
Current transfer ratio	I_C/I_F		$I_F = 1\text{ mA}, V_{CE} = 1\text{ V}$	1000	4000	—	%
Saturated current transfer ratio	$I_C/I_{F(sat)}$		$I_F = 10\text{ mA}, V_{CE} = 1\text{ V}$	500	—	—	%
Collector-emitter saturation voltage	$V_{CE(sat)}$		$I_C = 10\text{ mA}, I_F = 1\text{ mA}$	—	—	1.0	V
			$I_C = 100\text{ mA}, I_F = 10\text{ mA}$	0.3	—	1.2	
OFF-state collector current	$I_{C(off)}$		$V_F = 0.7\text{ V}, V_{CE} = 200\text{ V}$	—	—	20	μA

9. Isolation Characteristics (Unless otherwise specified, $T_a = 25\text{ }^\circ\text{C}$)

Characteristics	Symbol	Note	Test Condition	Min	Typ.	Max	Unit
Total capacitance (input to output)	C_S	(Note 1)	$V_S = 0\text{ V}, f = 1\text{ MHz}$	—	0.6	—	pF
Isolation resistance	R_S	(Note 1)	$V_S = 500\text{ V}, \text{R.H.} \leq 60\%$	1×10^{12}	10^{14}	—	Ω
Isolation voltage	BV_S	(Note 1)	AC, 60 s	5000	—	—	V_{rms}
			AC, 1 s in oil	—	10000	—	
			DC, 60 s in oil	—	10000	—	Vdc

Note 1: This device is considered as a two-terminal device: Pins 1 and 3 are shorted together, and pins 4 and 6 are shorted together.

10. Switching Characteristics (Unless otherwise specified, $T_a = 25\text{ }^\circ\text{C}$)

Characteristics	Symbol	Note	Test Condition	Min	Typ.	Max	Unit
Rise time	t_r		$V_{CC} = 10\text{ V}, I_C = 10\text{ mA}, R_L = 100\ \Omega$	—	40	—	μs
Fall time	t_f			—	15	—	
Turn-on time	t_{on}			—	50	—	
Turn-off time	t_{off}			—	15	—	
Turn-on time	t_{on}		See Fig. 10.1 $R_L = 180\ \Omega, V_{CC} = 10\text{ V}, I_F = 16\text{ mA}$	—	5	—	
Storage time	t_s			—	40	—	
Turn-off time	t_{off}			—	80	—	

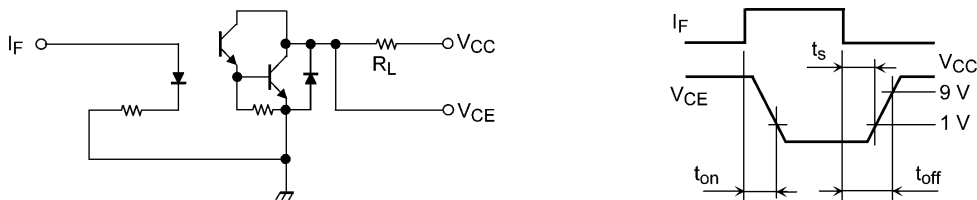

Fig. 10.1 Switching Time Test Circuit and Waveform

11. Characteristics Curves (Note)

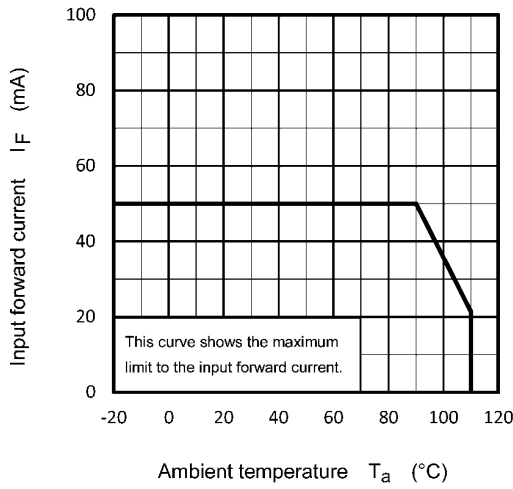

Fig. 11.1 $I_F - T_a$

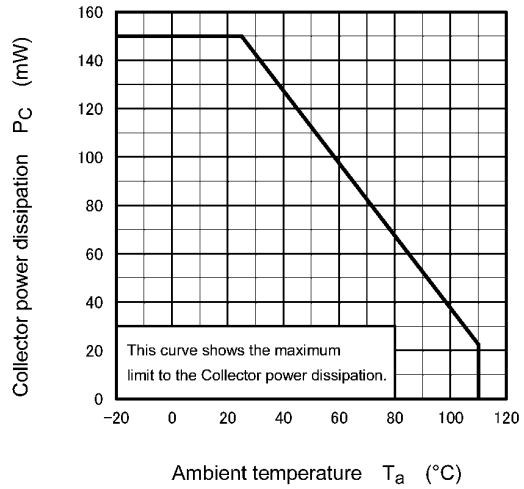

Fig. 11.2 $P_C - T_a$

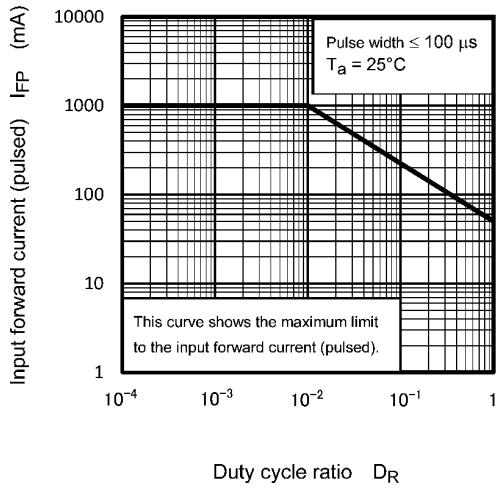

Fig. 11.3 $I_{FP} - D_R$

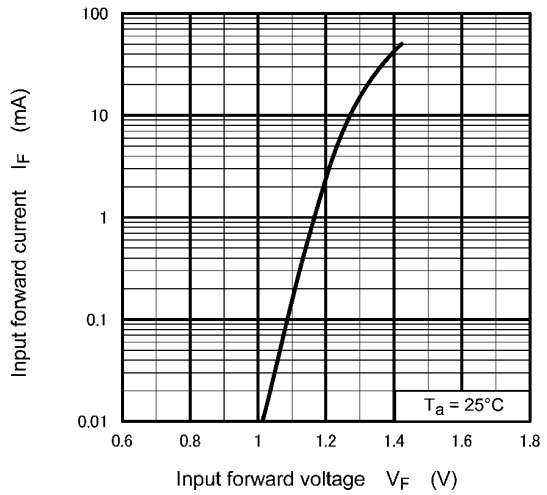

Fig. 11.4 $I_F - V_F$

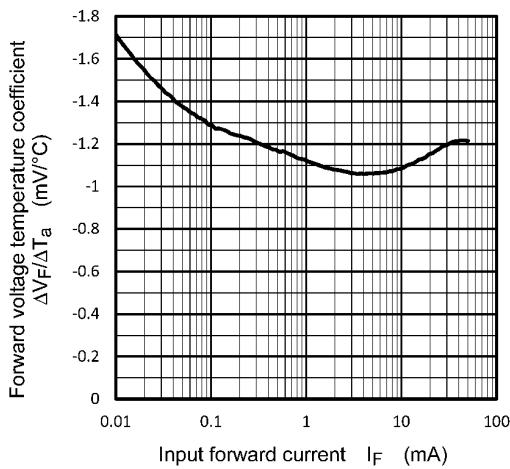

Fig. 11.5 $\Delta V_F/\Delta T_a - I_F$

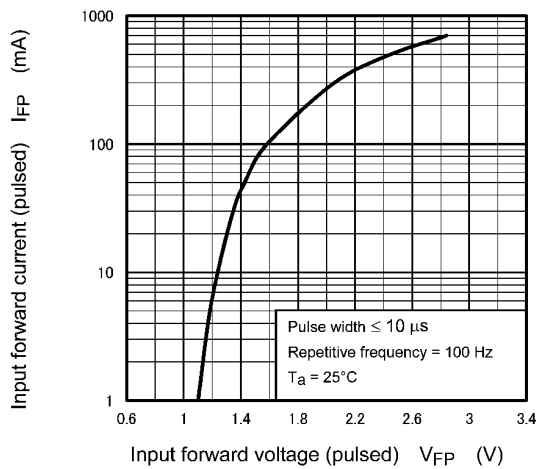

Fig. 11.6 $I_{FP} - V_{FFP}$

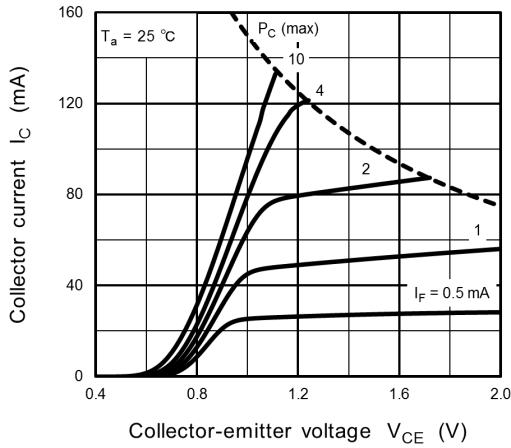

Fig. 11.7 $I_C - V_{CE}$

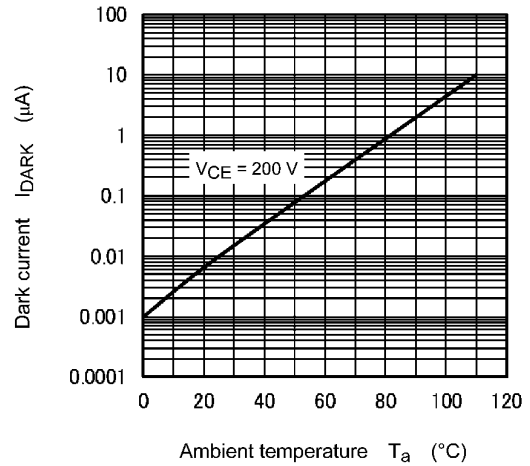

Fig. 11.8 $I_{DARK} - T_a$

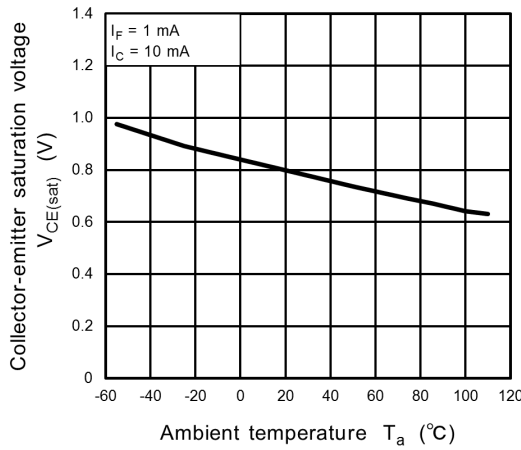

Fig. 11.9 $V_{CE(sat)} - T_a$

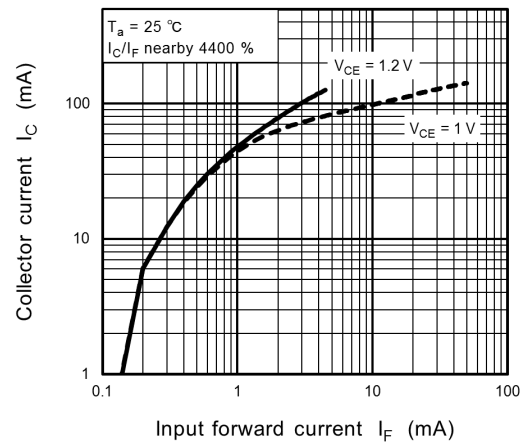

Fig. 11.10 $I_C - I_F$

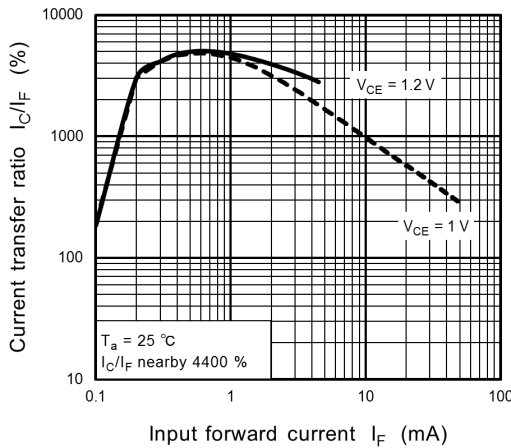

Fig. 11.11 $I_C/I_F - I_F$

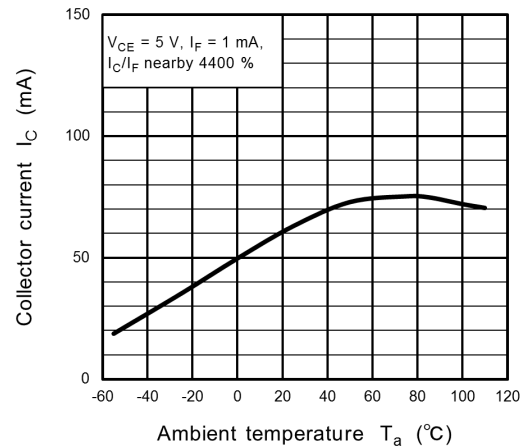

Fig. 11.12 $I_C - T_a$

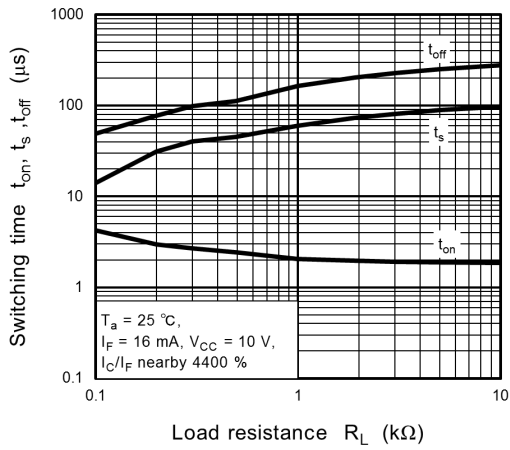

Fig. 11.13 Switching Time - R_L

Note: The above characteristics curves are presented for reference only and not guaranteed by production test, unless otherwise noted.

12. Soldering and Storage

12.1. Precautions for Soldering

The soldering temperature should be controlled as closely as possible to the conditions shown below, irrespective of whether a soldering iron or a reflow soldering method is used.

- When using soldering reflow.

The soldering temperature profile is based on the package surface temperature.

(See the figure shown below, which is based on the package surface temperature.)

Reflow soldering must be performed once or twice.

The mounting should be completed with the interval from the first to the last mountings being 2 weeks.

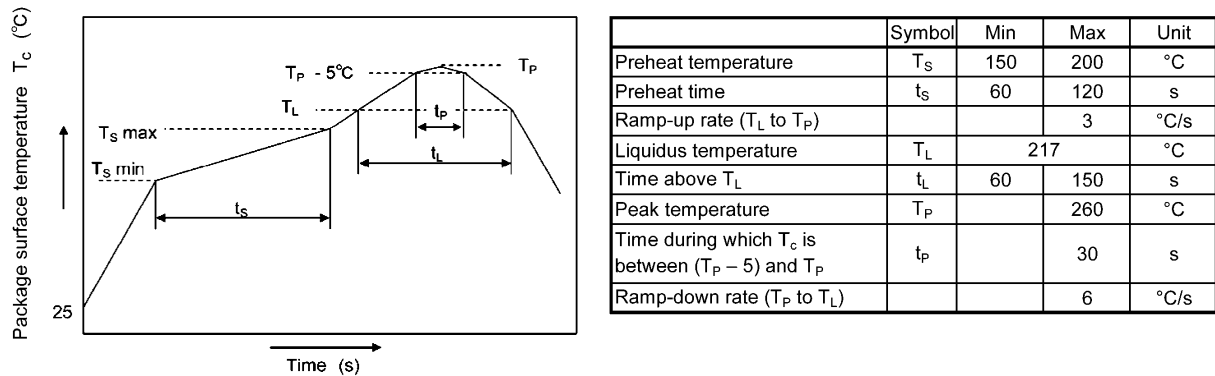

Fig. 12.1.1 An Example of a Temperature Profile When Lead(Pb)-Free Solder Is Used

- When using soldering flow
Preheat the device at a temperature of 150 °C (package surface temperature) for 60 to 120 seconds.
Mounting condition of 260 °C within 10 seconds is recommended.
Flow soldering must be performed once.
- When using soldering Iron
Complete soldering within 10 seconds for lead temperature not exceeding 260 °C or within 3 seconds not exceeding 350 °C
Heating by soldering iron must be done only once per lead.

12.2. Precautions for General Storage

- Avoid storage locations where devices may be exposed to moisture or direct sunlight.
- Follow the precautions printed on the packing label of the device for transportation and storage.
- Keep the storage location temperature and humidity within a range of 5 °C to 35 °C and 45 % to 75 %, respectively.
- Do not store the products in locations with poisonous gases (especially corrosive gases) or in dusty conditions.
- Store the products in locations with minimal temperature fluctuations. Rapid temperature changes during storage can cause condensation, resulting in lead oxidation or corrosion, which will deteriorate the solderability of the leads.
- When restoring devices after removal from their packing, use anti-static containers.
- Do not allow loads to be applied directly to devices while they are in storage.
- If devices have been stored for more than two years under normal storage conditions, it is recommended that you check the leads for ease of soldering prior to use.

13. Land Pattern Dimensions (for reference only)

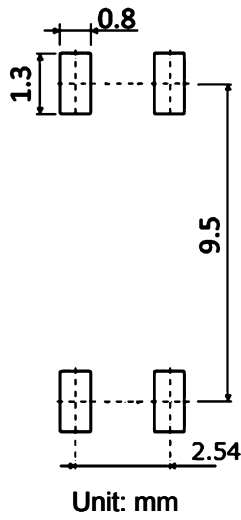

14. Marking

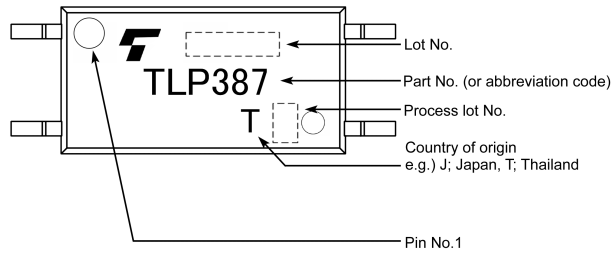

15. EN60747-5-5 Option (D4) Specification

- Part number: TLP387 (Note 1)
- The following part naming conventions are used for the devices that have been qualified according to option (D4) of EN60747.

Example: TLP387(D4-TPL,E(T

D4: EN60747 option

TPL: Tape type (L direction)

E: [[G]]/RoHS COMPATIBLE (Note 2)

T: Domestic ID (Country/Region of origin: Thailand)

Note 1: Use TOSHIBA standard type number for safety standard application.

e.g., TLP387(D4-TPL,E(T → TLP387

Note 2: Please contact your Toshiba sales representative for details on environmental information such as the product's RoHS compatibility.

RoHS is the Directive 2011/65/EU of the European Parliament and of the Council of 8 June 2011 on the restriction of the use of certain hazardous substances in electrical and electronics equipment.

Description	Symbol	Rating	Unit
Application classification for rated mains voltage ≤ 150 Vrms for rated mains voltage ≤ 300 Vrms		I-IV I-III	—
Climatic classification		55 / 125 / 21	—
Pollution degree		2	—
Maximum operating insulation voltage	V _{IORM}	1230	V _{peak}
Input to output test voltage, Method A V _{pr} = 1.6 × V _{IORM} , type and sample test t _p = 10 s, partial discharge < 5 pC	V _{pr}	1970	V _{peak}
Input to output test voltage, Method B V _{pr} = 1.875 × V _{IORM} , 100 % production test t _p = 1 s, partial discharge < 5 pC	V _{pr}	2310	V _{peak}
Highest permissible overvoltage (transient overvoltage, t _{pr} = 60 s)	V _{TR}	8000	V _{peak}
Safety limiting values (max. permissible ratings in case of fault, also refer to thermal derating curve) current (input current I _F , P _{so} = 0) power (output or total power dissipation) temperature	I _{si} P _{so} T _s	250 400 150	mA mW °C
Insulation resistance V _{IO} = 500 V, T _a = 25 °C V _{IO} = 500 V, T _a = 100 °C V _{IO} = 500 V, T _a = T _s	R _{si}	≥ 10 ¹² ≥ 10 ¹¹ ≥ 10 ⁹	Ω

Fig. 15.1 EN60747 Insulation Characteristics

Table 15.1 Insultion Related Specifications (Note)

Insulation Related Specification	Symbol	TLP387
Minimum creepage distance	Cr	8.0 mm
Minimum clearance	Cl	8.0 mm
Minimum insulation thickness	ti	0.4 mm
Comparative tracking index	CTI	175

Note: This photocoupler is suitable for **safe electrical isolation** only within the safety limit data. Maintenance of the safety data shall be ensured by means of protective circuits.



Fig. 15.2 Marking on packing for EN60747

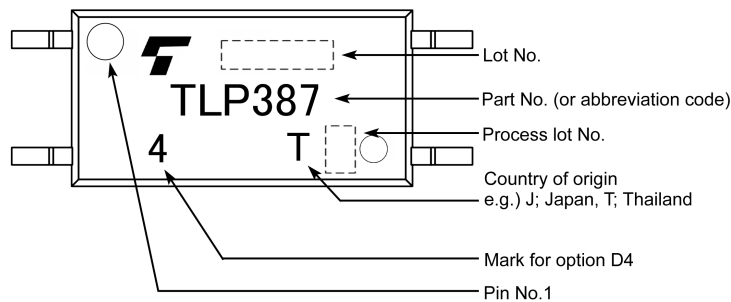

Fig. 15.3 Marking Example (Note 1)

Note 1: The above marking is applied to the photocouplers that have been qualified according to option (D4) of EN60747.

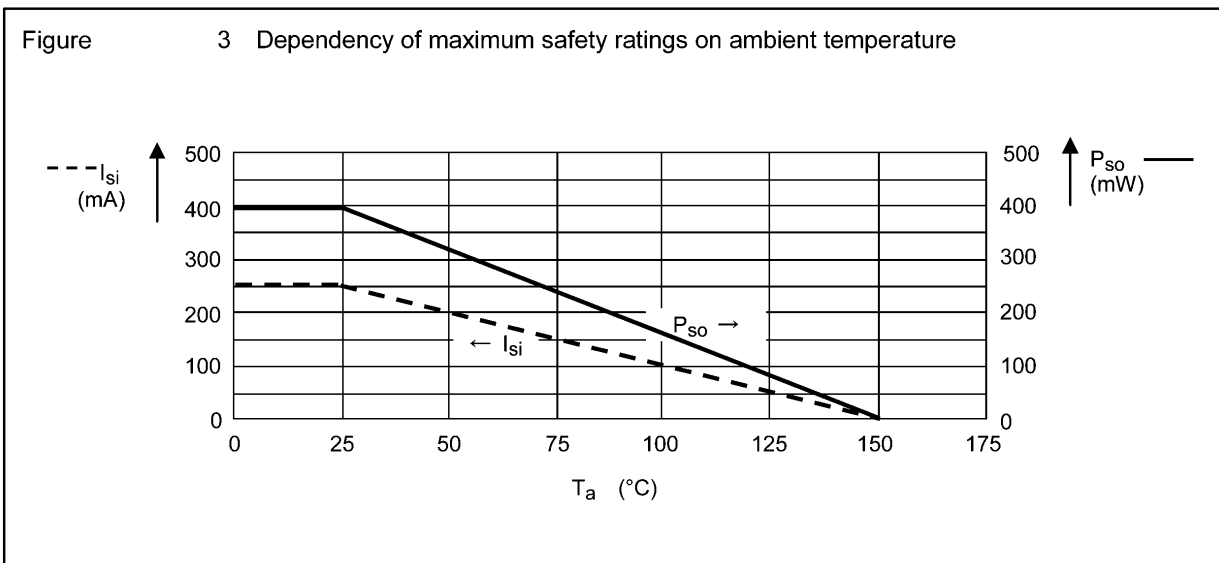
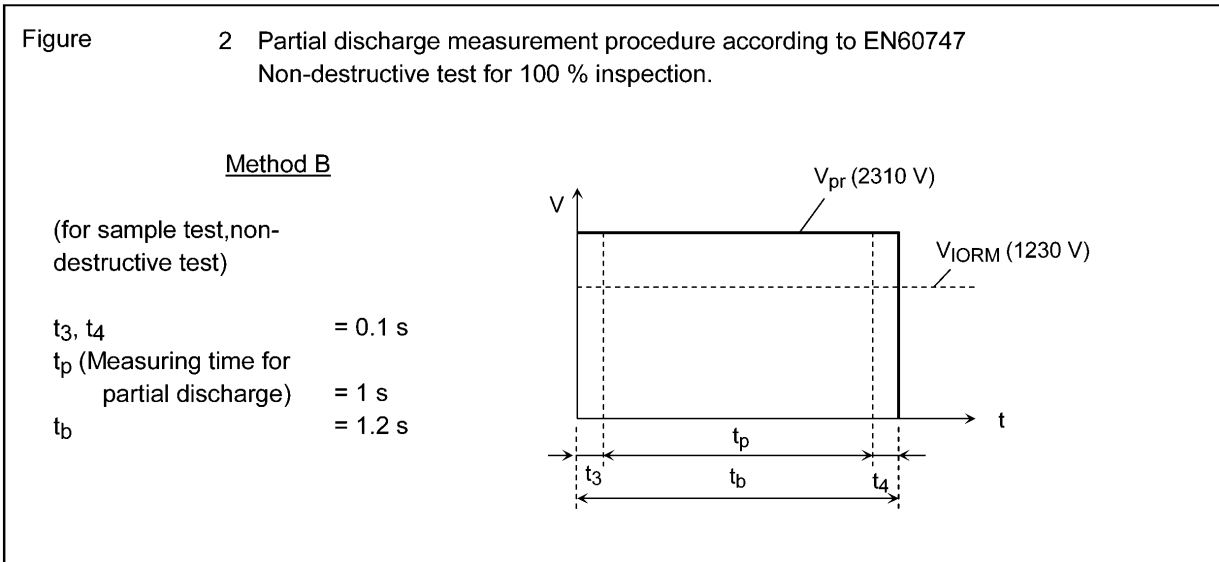
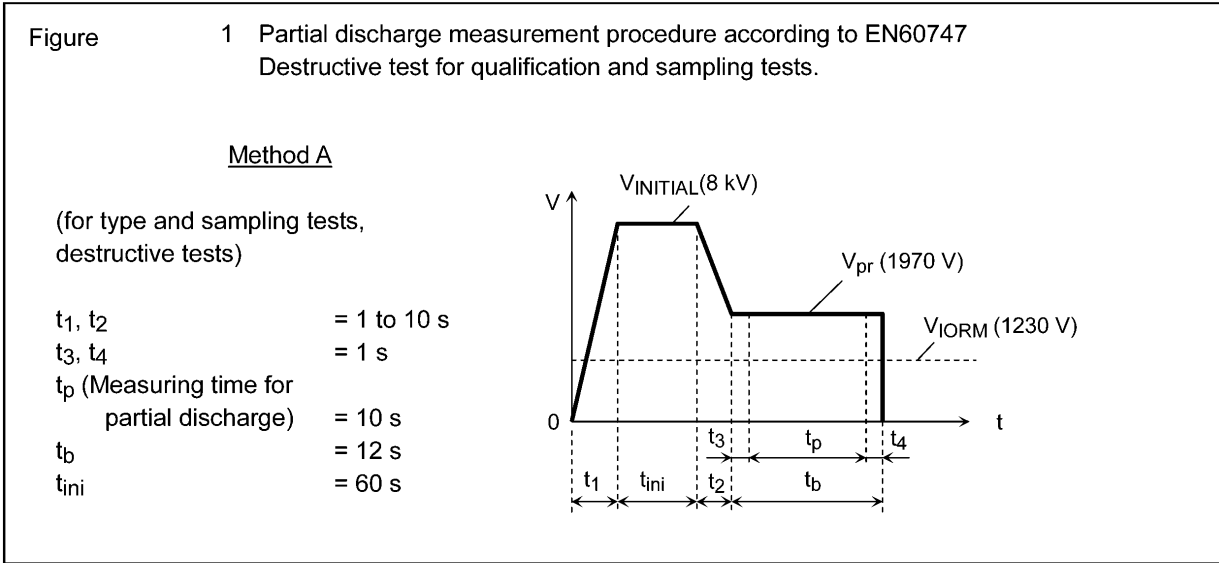

Fig. 15.4 Measurement Procedure

16. Embossed-Tape Packing (TPL),(TPR) Specification for Mini-Flat Photocouplers

16.1. Applicable Package

Package Name	Product Type
SO6L	Long creepage mini flat coupler

16.2. Product Naming Conventions

Type of package used for shipment is denoted by a symbol suffix after a part number. The method of classification is as below.

Example) TLP387(TPL,E(T

Part number: TLP387

Tape type: TPL

[[G]]/RoHS COMPATIBLE: E (**Note 1**)

Domestic ID (Country of origin: Thailand): T

Note 1: Please contact your Toshiba sales representative for details on environmental information such as the product's RoHS compatibility.

RoHS is the Directive 2011/65/EU of the European Parliament and of the Council of 8 June 2011 on the restriction of the use of certain hazardous substances in electrical and electronics equipment.

16.3. Tape Dimensions Specification

Tape Type	Division	Packing Amount (A unit per reel)
TPL	L direction	3000
TPR	R direction	3000

16.3.1. Orientation of Device in Relation to Direction of Feed

Device orientation in the carrier cavities as shown in the following figure.

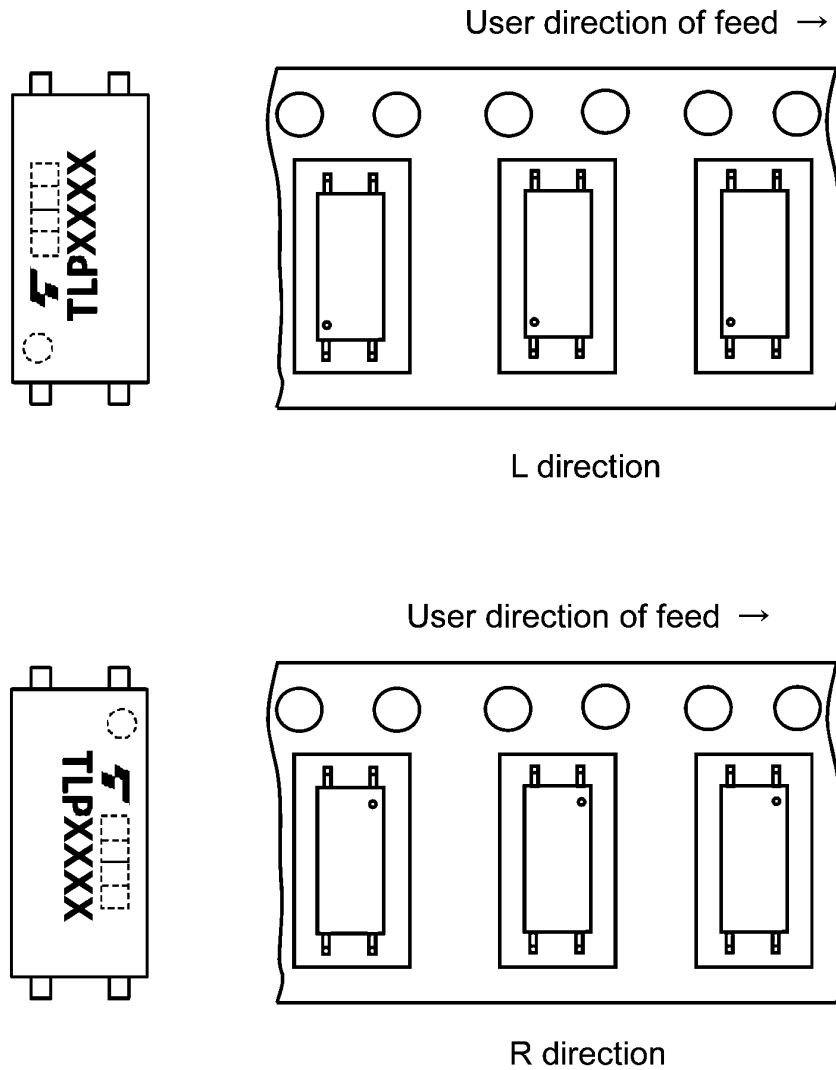

Fig. 16.3.1.1 Device Orientation

16.3.2. Empty Cavities

Characteristics	Criterion	Remarks
Occurrences of 2 or more successive empty cavities	0 device	Within any given 40-mm section of tape, not including leader and trailer
Single empty cavity	6 devices (max) per reel	Not including leader and trailer

16.3.3. Tape Leader and Trailer

The start end of the tape has 25 or more empty cavities. The hub end of the tape has 20 or more empty cavities and 1 empty turns for a cover tape.

16.3.4. Tape Dimensions

Tape material: Plastic (for protection against static electricity)

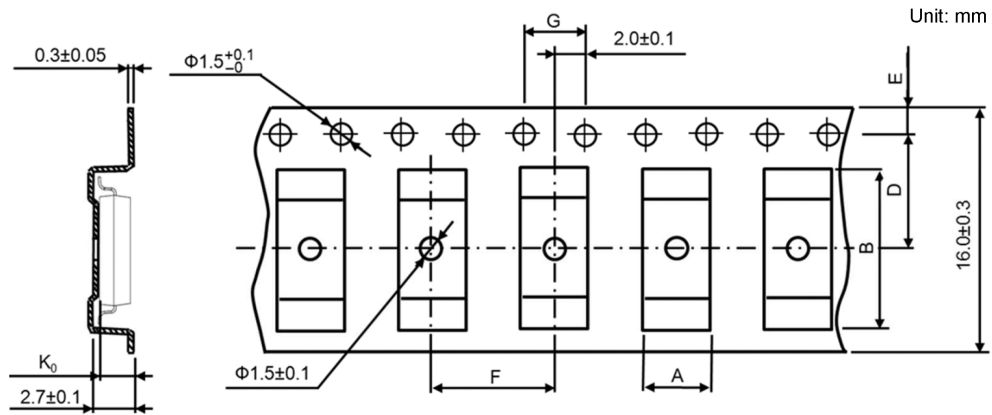

Fig. 16.3.4.1 Tape Dimensions

Table 16.3.4.1 Tape Dimensions (unit: mm, tolerance: ±0.1)

Symbol	Dimension	Remark
A	4.24	—
B	10.4	—
D	7.5	Center line of embossed cavity and sprocket hole
E	1.75	Distance between tape edge and sprocket hole center
F	8.0	
G	4.0	Cumulative error +0.2/-0.3 (max) per 10 sprocket holes
K ₀	2.4	Internal space

16.3.5. Reel Specification

Material: Plastic

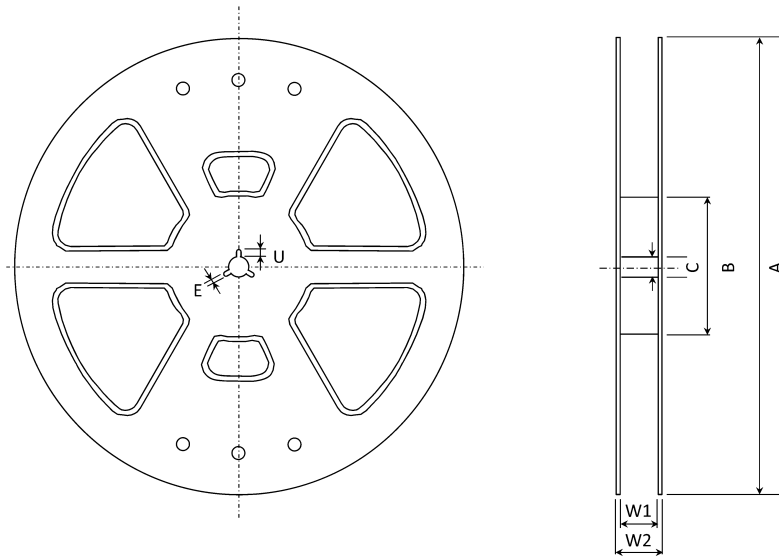

Fig. 16.3.5.1 Reel Dimensions

Table 16.3.5.1 Reel Dimensions (unit: mm)

Symbol	Dimension
A	$\phi 330 \pm 2$
B	$\phi 100 \pm 1$
C	$\phi 13 \pm 0.5$
E	2.0 ± 0.5
U	4.0 ± 0.5
W1	17.5 ± 0.5
W2	21.4 ± 1.0

16.4. Packing (Note)

Either one reel or ten reels of photocouplers are packed in a shipping carton.

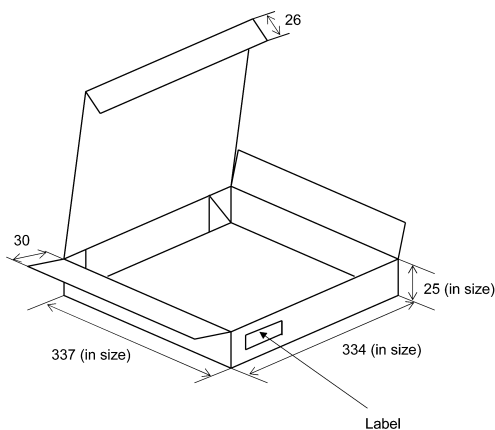

Fig. 16.4.1 1 reel/carton (unit: mm)

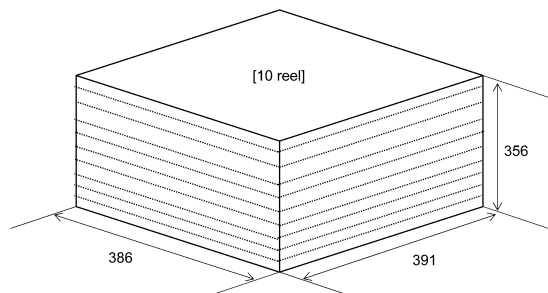

Fig. 16.4.2 10 reel/carton (unit: mm)

Note: Taping reel diameter: $\phi 330 \pm 2$ mm

16.5. Label Format

- (1) Carton: The label provides the part number, quantity, lot number, the Toshiba logo, etc.
- (2) Reel: The label provides the part number, the taping name, quantity, lot number, etc.

16.6. Ordering Information

When placing an order, please specify the part number, tape type and quantity as shown in the following example.

Example) TLP387(TPL,E(T 3000 pcs

Part number: TLP387

Tape type: TPL (L-direction)

[[G]]/RoHS COMPATIBLE: E (**Note 1**)

Domestic ID (Country/Region of origin: Thailand): T

Quantity (must be a multiple of 3000): 3000 pcs

Note 1: Please contact your Toshiba sales representative for details on environmental information such as the product's RoHS compatibility.

RoHS is the Directive 2011/65/EU of the European Parliament and of the Council of 8 June 2011 on the restriction of the use of certain hazardous substances in electrical and electronics equipment.

Package Dimensions

Unit: mm

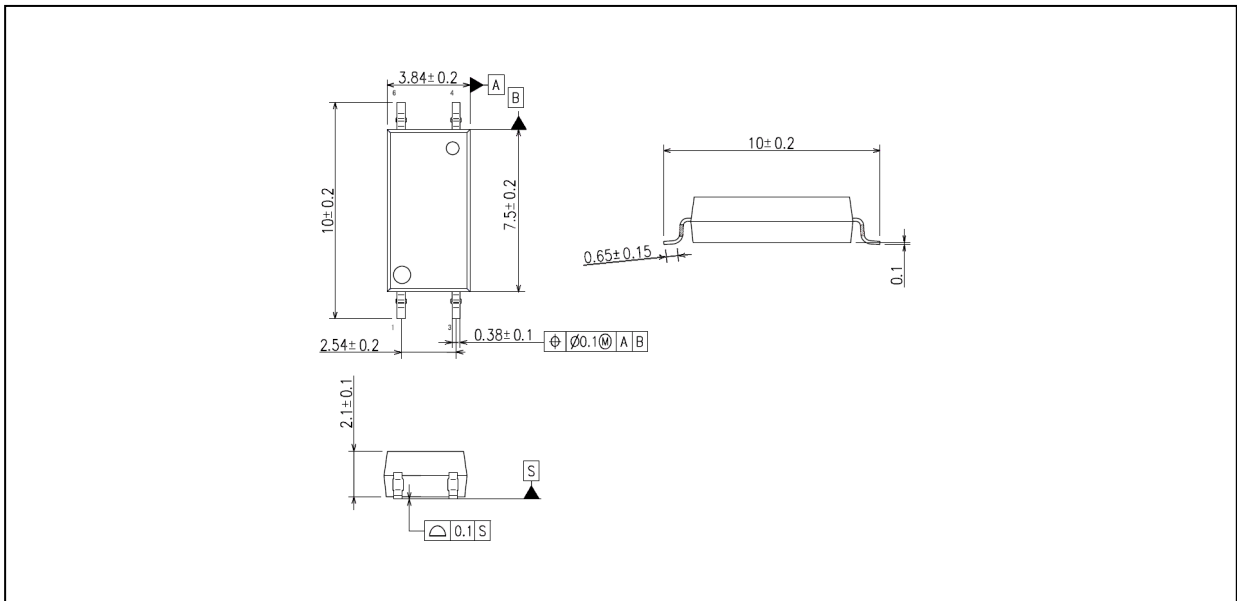

Weight: 0.128 g (typ.)

Package Name(s)
TOSHIBA: 11-4P1A

RESTRICTIONS ON PRODUCT USE

- Toshiba Corporation, and its subsidiaries and affiliates (collectively "TOSHIBA"), reserve the right to make changes to the information in this document, and related hardware, software and systems (collectively "Product") without notice.
- This document and any information herein may not be reproduced without prior written permission from TOSHIBA. Even with TOSHIBA's written permission, reproduction is permissible only if reproduction is without alteration/omission.
- Though TOSHIBA works continually to improve Product's quality and reliability, Product can malfunction or fail. Customers are responsible for complying with safety standards and for providing adequate designs and safeguards for their hardware, software and systems which minimize risk and avoid situations in which a malfunction or failure of Product could cause loss of human life, bodily injury or damage to property, including data loss or corruption. Before customers use the Product, create designs including the Product, or incorporate the Product into their own applications, customers must also refer to and comply with (a) the latest versions of all relevant TOSHIBA information, including without limitation, this document, the specifications, the data sheets and application notes for Product and the precautions and conditions set forth in the "TOSHIBA Semiconductor Reliability Handbook" and (b) the instructions for the application with which the Product will be used with or for. Customers are solely responsible for all aspects of their own product design or applications, including but not limited to (a) determining the appropriateness of the use of this Product in such design or applications; (b) evaluating and determining the applicability of any information contained in this document, or in charts, diagrams, programs, algorithms, sample application circuits, or any other referenced documents; and (c) validating all operating parameters for such designs and applications. **TOSHIBA ASSUMES NO LIABILITY FOR CUSTOMERS' PRODUCT DESIGN OR APPLICATIONS.**
- **PRODUCT IS NEITHER INTENDED NOR WARRANTED FOR USE IN EQUIPMENTS OR SYSTEMS THAT REQUIRE EXTRAORDINARILY HIGH LEVELS OF QUALITY AND/OR RELIABILITY, AND/OR A MALFUNCTION OR FAILURE OF WHICH MAY CAUSE LOSS OF HUMAN LIFE, BODILY INJURY, SERIOUS PROPERTY DAMAGE AND/OR SERIOUS PUBLIC IMPACT ("UNINTENDED USE").** Except for specific applications as expressly stated in this document, Unintended Use includes, without limitation, equipment used in nuclear facilities, equipment used in the aerospace industry, medical equipment, equipment used for automobiles, trains, ships and other transportation, traffic signaling equipment, equipment used to control combustions or explosions, safety devices, elevators and escalators, devices related to electric power, and equipment used in finance-related fields. **IF YOU USE PRODUCT FOR UNINTENDED USE, TOSHIBA ASSUMES NO LIABILITY FOR PRODUCT.** For details, please contact your TOSHIBA sales representative.
- Do not disassemble, analyze, reverse-engineer, alter, modify, translate or copy Product, whether in whole or in part.
- Product shall not be used for or incorporated into any products or systems whose manufacture, use, or sale is prohibited under any applicable laws or regulations.
- The information contained herein is presented only as guidance for Product use. No responsibility is assumed by TOSHIBA for any infringement of patents or any other intellectual property rights of third parties that may result from the use of Product. No license to any intellectual property right is granted by this document, whether express or implied, by estoppel or otherwise.
- **ABSENT A WRITTEN SIGNED AGREEMENT, EXCEPT AS PROVIDED IN THE RELEVANT TERMS AND CONDITIONS OF SALE FOR PRODUCT, AND TO THE MAXIMUM EXTENT ALLOWABLE BY LAW, TOSHIBA (1) ASSUMES NO LIABILITY WHATSOEVER, INCLUDING WITHOUT LIMITATION, INDIRECT, CONSEQUENTIAL, SPECIAL, OR INCIDENTAL DAMAGES OR LOSS, INCLUDING WITHOUT LIMITATION, LOSS OF PROFITS, LOSS OF OPPORTUNITIES, BUSINESS INTERRUPTION AND LOSS OF DATA, AND (2) DISCLAIMS ANY AND ALL EXPRESS OR IMPLIED WARRANTIES AND CONDITIONS RELATED TO SALE, USE OF PRODUCT, OR INFORMATION, INCLUDING WARRANTIES OR CONDITIONS OF MERCHANTABILITY, FITNESS FOR A PARTICULAR PURPOSE, ACCURACY OF INFORMATION, OR NONINFRINGEMENT.**
- GaAs (Gallium Arsenide) is used in Product. GaAs is harmful to humans if consumed or absorbed, whether in the form of dust or vapor. Handle with care and do not break, cut, crush, grind, dissolve chemically or otherwise expose GaAs in Product.
- Do not use or otherwise make available Product or related software or technology for any military purposes, including without limitation, for the design, development, use, stockpiling or manufacturing of nuclear, chemical, or biological weapons or missile technology products (mass destruction weapons). Product and related software and technology may be controlled under the applicable export laws and regulations including, without limitation, the Japanese Foreign Exchange and Foreign Trade Law and the U.S. Export Administration Regulations. Export and re-export of Product or related software or technology are strictly prohibited except in compliance with all applicable export laws and regulations.
- Please contact your TOSHIBA sales representative for details as to environmental matters such as the RoHS compatibility of Product. Please use Product in compliance with all applicable laws and regulations that regulate the inclusion or use of controlled substances, including without limitation, the EU RoHS Directive. **TOSHIBA ASSUMES NO LIABILITY FOR DAMAGES OR LOSSES OCCURRING AS A RESULT OF NONCOMPLIANCE WITH APPLICABLE LAWS AND REGULATIONS.**

Mouser Electronics

Authorized Distributor

Click to View Pricing, Inventory, Delivery & Lifecycle Information:

Toshiba:

[TLP387\(D4-TPL,E](#) [TLP387\(TPR,E](#) [TLP387\(TPL,E](#) [TLP387\(D4-TPR,E](#) [TLP387\(D4,E](#) [TLP387\(E](#)